



## ***Tube Topics*** (Edition 2)

### **Introduction**

Webster's *New Collegiate Dictionary* defines rebuild as "(a): to make extensive repairs to; (b): to restore to a previous state". The goal of ECONCO is to achieve definition (b) with "a previous state" being a new tube. To accomplish this goal, we frequently must resort to definition (a). ECONCO repairs or replaces all parts within a tube requiring repair to attain this goal.

At ECONCO, considerable efforts are made to analyze the cause for failure and counsel users on preventive actions. Within the design limitations of the tube, we rebuild in a manner to minimize these types of failure. The nature of our business requires testing large numbers of end-of-life tubes—both low emission and catastrophic failures—giving us a unique understanding of the strengths and weaknesses of various power tube designs. We have, in fact, conducted failure analysis on well over 200,000 tubes from virtually every tube manufacturer in the world.

ECONCO is happy to provide telephone support to any tube user who is experiencing problems with a device. This service is available to all tube users regardless of their source of tubes. We can provide copies of data sheets for most common power tubes.

Duds are the lifeblood of the tube rebuilding business. We encourage all tube users to sell their duds to ECONCO whether they choose to use our services or not. Our continued presence in the industry creates competition and acts as a restraint on price increases of new tubes.

The second edition of *Tube Topics* is dedicated to helping our customers understand the rebuilding process, and—in the process—improve the reliability of their equipment.

### **Contents**

Basic Tube Design	1-6
Tube Maintenance	7-18
The Tube Rebuilding Process	19-25
Tube Ratings Data for Devices Rebuilt by ECONCO	26-30



### Section 1: Basic Tube Design

A vacuum tube consists of a vacuum envelope containing various electronic elements used to emit, control, and collect a flow of electrons. A *filament* or *cathode* provides a source of electron emission. Up to three grids; the *control*, *screen*, and *suppressor* grids control the flow of electrons within the tube and a *plate* or *anode* collects the electron flow. Electrical energy that is not transferred to the load is converted to heat at the anode.

Figure 1 shows the interior elements of a tetrode. These elements are mounted and aligned parallel and concentric with each other but are electrically isolated, as shown in Figure 2. In the example device, each bar and spiral of the screen grid is “hidden” from the filament by a corresponding control grid bar.

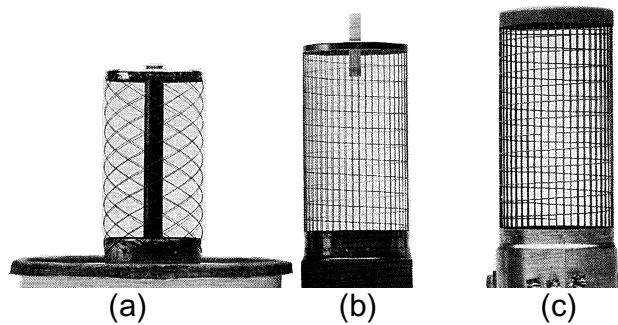

**Figure 1.** The interior of a tetrode: (a) mesh filament, (b) control grid (c) screen grid

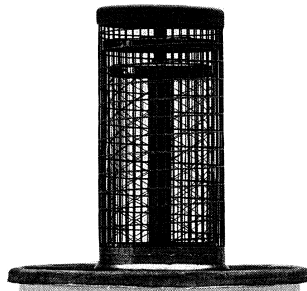

**Figure 2.** Interior assembly of a power tetrode.

## 1.1 Electron Emitter Types

The electron emitters in vacuum tubes are either directly heated or indirectly heated. The tube types we are concerned with in this booklet are directly heated, filamentary tubes.

Operating techniques that are proper for filamentary tubes are not necessarily correct for tubes with indirectly heated cathode emitters. In particular, the operation of cathode types at reduced heater voltage can be destructive to the tube.

### Filament Designs

Directly heated tubes have either *spiral*, *parallel bar*, *hairpin*, or *mesh* filament structures. The spiral filament structure consists of one or two strands of wire that are spiral wrapped around a central support rod. They are found in older, lower power designs. Spiral filaments are subject to sagging and shorting between the turns. As illustrated in Figure 3, the filament in (a) is normal while the filament shown in (b) has sagged because of excess filament voltage. These particular tubes operate inverted. Note the shorted turns at the top of (b).

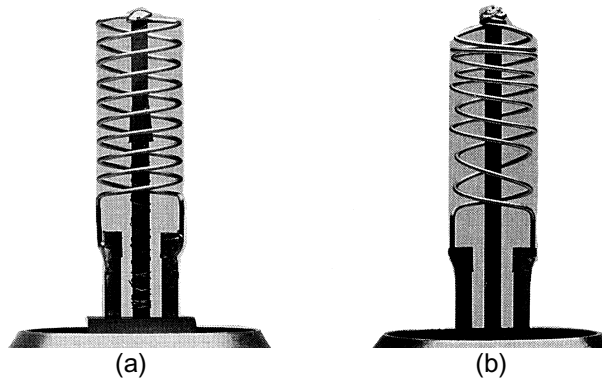

**Figure 3.** 5762/7C24 spiral filaments: (a) normal filament, (b) abnormal filament

The hairpin structure is found in many power tubes currently installed. It consists of a number of parallel elements bent into the shape of a hairpin (thus the name). The current path is up one leg, across the top, and down the adjacent leg. Hairpin filament support structures have built in spring compensation for thermal expansion of the filament (Figure 4.). These filament structures can have all voltages applied without filament warm-up. Tuning will drift slightly because of relative movement of the tube elements as they reach thermal equilibrium, but there is no danger of shorting. Some tube designs require surge current limitation for the filament when initially turned on. This protection should be provided for by the equipment manufacturer and should not be bypassed.

**Figure 4.** The hairpin filament structure

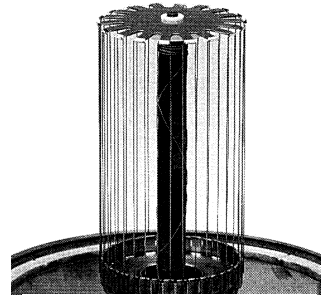

**Figure 5.** Mesh filament structure

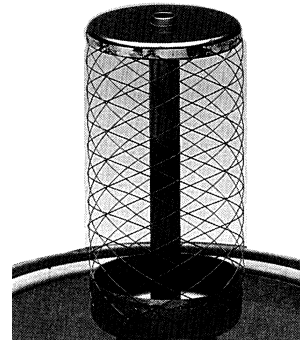

Mesh filaments are composed of filament wires woven to form a basket weave filament structure. (Figure 5.) The wire joints are spotwelded or diffusion bonded at the intersections. Mesh filaments are being designed into most new tube designs on the theory that a mesh filament permits a denser, more closely spaced structure. This allows higher stage gain, increased efficiency and higher frequency operation.

The mesh structure relies on thermal expansion of the ridged upper filament support structure to compensate for thermal expansion of the filament. The current path is from the base, up through mesh filament, across top, and down through the center support rod. Mesh filaments require slower warm-up as the thin, low mass filament wires come to temperature immediately as voltage is applied. As they heat, they expand, and until the more massive and slower to heat support structures reach their operating temperature to compensate for this expansion, the filament wires warp in and out. A warped filament greatly increases the possibility of a thermal grid-to-filament short circuit. Common precautions for filament operation are detailed in Section 2.5 (“Filament Voltage”). Attention to filament voltage is vital to long life and stable operation of filamentary tubes.

## 1.2 Grids

Grid elements are generally formed of wires spotwelded together to form a circular structure that completely surrounds the emitting surface of the filament. The grid controls the flow of electrons from the filament. Grids are coated with various materials compounded to manage the emission of electrons from the

grid. If emission of electrons from the grid is uncontrolled, it can result in high distortion or a destructive *runaway* effect in the tube.

### 1.3 Anode

Anodes are copper cylinders or drawn cups that collect the flow of electrons within a tube. They have air cooling fins, vapor cooling surfaces, or water cooling jackets brazed to their exterior in order to remove the heat generated by the power not transferred to the load.

### Plating

The external metal parts of tubes are plated with nickel or silver. Tubes that go into sockets are normally silver plated. The soft silver provides a better contact interface than the much harder nickel; it deforms slightly under contact pressure providing greater contact area. Silver plating has a dull, whitish cast, whereas nickel has a hard metallic appearance.

Nickel is resistant to discoloration resulting from heat at normal tube operating temperatures, while silver will tarnish easily. Often, the heat patterns on silver plated tubes are helpful in problem analysis. If a nickel plated tube shows any sign of heat discoloration, a significant cooling or operational problem exists. Nickel will not discolor until it reaches a temperature much higher than a tube will reach under normal conditions. If a nickel plated tube discolors, abnormal operating conditions are present.

### Safety

Power tubes and the equipment they are installed in have electrical voltages present that can be lethal. The access panels to all high voltage cabinets should be installed. All interlocks should be operating and never bypassed. High voltage cabinets should be equipped with a shorting bar, which should be directly grounded. The bar is used to ground all high voltage areas before reaching into them to work on or inspect any components.

Proper equipment design requires that all high voltage circuits have *bleeder resistors* to bleed off any residual charge to ground when the equipment is turned off. Full discharge by these bleeder circuits may take several seconds.

### 1.4 Sockets

Prior to installing a tube, it is wise to inspect the socket to determine if there are any broken pieces of fingerstock. Broken pieces of fingerstock can fall into the equipment causing shorts and other damage. They should be located and removed prior to installation of the tube. Individual finger contacts can break off on occasion and as long as they are located and removed, the socket ring does not require replacement. If more than 20 percent of fingerstock are broken off, the contact ring should be replaced. Consecutive gaps around the tube can cause improper tuning, instability, and lead to premature failure.

Repair kits are available for most sockets from manufacturers. This method is far cheaper than replacing the entire socket. ECONCO is happy to advise a tube user as to where specific socket replacement parts can be obtained.

## Socket Problems

Loose contact on a tube socket will always lead to problems. Some socket designs have a wire-wound spring encircling the outside circumference of the fingerstock to increase individual finger contact pressure. These should be replaced if they break or lose tension. Adequate contact pressure is vital for proper operation and long life. Some sockets have stops that are set so that the tube has the grid contacts in the middle of the contact area when fully inserted. This positioning can be checked by inserting and then removing a new tube. The scratch marks on the grid contacts will show the position of the tube relative to the socket contacts.

Figure 6 shows a burned and melted grid ring on an industrial triode. This failure was caused by poor contact between the grid ring and the socket.

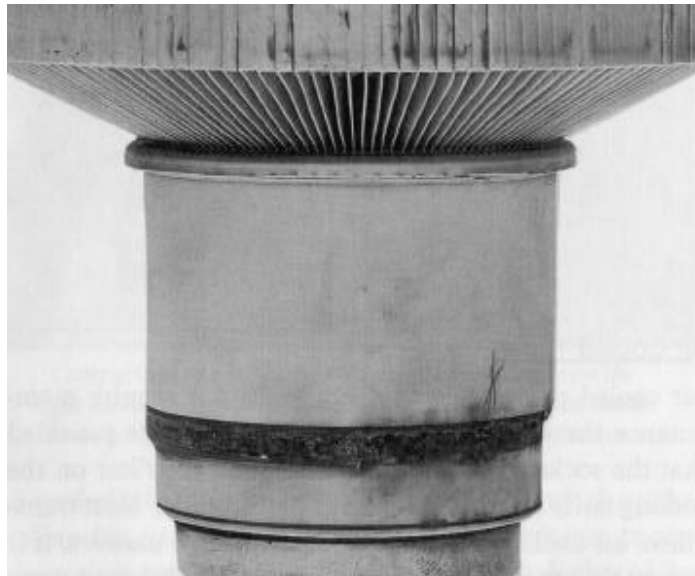

**Figure 6.** An industrial triode that failed because of socketing problems.

## Tube Insertion

Gently rock and slightly rotate the tube as it is being inserted into the socket. This helps avoid bending and breaking of fingerstock. Be sure to apply sufficient force to seat the tube all the way into the socket. Never use a lever or hammer on the tube to set it into the socket. Manual pressure should be adequate. An intermediate point is reached when the grid contact fingerstock slides up the tube sides and first contacts the connection areas. It is important to be sure the tube is fully inserted in the socket beyond this initial point of resistance.

## Tubes Without Sockets

Many industrial tubes and tubes used in medium-wave service are not socketed but are installed into the equipment by bolted or clamped connections. Clamped anode connections made of stainless steel should have some method of strain relief to avoid excess pressure collapsing the anode of the tube as it heats up in

operation. Stainless steel has a much lower coefficient of thermal expansion than copper.

All bolted or screwed connections should be tight. It is important to check that the clamps are snug, providing good electrical contact around the entire circumference of the contact area. Because of the radio frequency fields present, all clamps and bolts should be made from non-magnetic materials. Copper, brass, or non-magnetic Series 300 stainless steel fasteners are preferred. Stainless steel is not a good conductor of electricity, and while it is used for clamping, it should not be part of the current path.



## Section 2: Tube Maintenance

With the single exception of the temperature necessary to obtain proper filament electron emission, heat is the primary enemy of vacuum tubes.

### 2.1 Air Cooled Tubes

Air cooled power tubes generally do not require maintenance throughout their normal operating life, provided that the socket is in good condition and the filter on the cooling fan is cleaned or replaced periodically. Most equipment air cooling is done with squirrel cage blowers. It is extremely important to check the impeller blades on these blowers. The blades can fill with dirt, drastically reducing their efficiency and therefore airflow through the tube. The blades should be scrapped with either a screw driver blade or knife to remove caked on dirt. In conditions where dirt, bugs or dust are present, the cooling fins on the anode should be checked for dirt. If they are plugged, remove the tube and use an air hose to blow the dirt from the fins. Blow the cleaning air in the reverse direction of normal air flow through the tube. Particular attention should be paid to the area of the tube where the cooling fin is attached to the anode. The greatest blockage occurs at the point where the cooling air first hits the fins. This is also the point of maximum temperature and therefore maximum heat transfer to the airflow.

Air cooled tubes require greater air flow when operated at higher altitudes because of the decreased density of the cooling air. Tube data sheets give cooling system correction information for high altitude operation. External arcing at high altitude may also require a lowering of plate and screen voltages because of the lower insulating value of air at high altitudes.

Air cooled tubes should have an air interlock switch on the cooling fan to prevent application of any voltages to the tube unless cooling air is flowing. Check the switch for proper operation. The heat generated by the filament alone can destroy a tube without cooling air flow.

Equipment should never have air duct work fastened directly to the cabinet top. Ducting increases backpressure, restricting airflow, which can result in excess tube temperature. Some exhaust ducting includes fans to help move exhaust air. However, if not properly designed, such devices can actually reduce airflow. Also, if the booster fan fails it will significantly reduce the cooling air flow. In



situations where it is felt necessary to install ducting to remove exhaust air, it is advisable to construct a hood over the equipment with a six inch open air gap between the equipment and the ductwork.

## **2.2 Liquid Cooled Tubes**

Water and vapor cooled tubes should be supplied with clean, filtered, low conductivity water, ideally from a closed system. Install a strainer on the tube input side. A screen mesh of  $36 \times 36$  per inch should provide adequate filtering. The system must be free of solid materials such as Teflon pipe tape and rust to prevent blockage of small cooling passages and subsequent tube overheating. Install a flow interlock switch on the tube outlet line.

Certain liquid cooled tubes are sensitive to the direction of water flow. The direction of water flow may be a function of whether the tube is mounted with its anode up or down. Adequate water flow is critical in water cooled tubes to prevent localized boiling and destruction of the tube. Check the tube data sheet for information on direction of flow and cooling water volume requirements.

Vapor cooled tubes require the correct water level be maintained. Check for scale buildup on the anode every six months, as scale can destructively reduce the heat transfer from the anode to the cooling water. Water condition is very important in vapor cooled installations; steam is active chemically and will react with the materials in the system to form contaminants.

## **2.3 Tuning**

Each equipment manufacturer provides instruction or guidelines for proper tuning and operation of their systems, which should be followed closely when adjusting the equipment.

Operate the power tubes in the equipment at their rated filament voltage whenever tuning or adjusting the equipment—not at reduced levels. This assures adequate emission levels from the tube and reduces the chances of low filament voltage masking performance levels that should be achieved through proper tuning and adjustment. After all adjustments are complete, the filament voltage may be set (as described in Section 2.5) to achieve maximum tube life.

## **2.4 Normal Tube Operation**

Whenever a tube is received from the supplier it is a good idea to inspect the package and check the tube for physical damage as soon as possible. Tubes are fragile and subject to shipping damage despite the care taken in packaging. Open the box and remove the tube. A check with a VOM meter can make a quick evaluation for broken filaments. Carefully lay the tube on its side and check for continuity (a short) between the two filament contacts. The filament contacts should indicate a short as the filament resistance is very low when cold. Also, check to see that there is no continuity (open circuit) between either filament connection and the other tube elements. The only continuity should be between the filament contacts, with all other elements being electrically isolated from the filament and each other. If the tube shows a short-circuit, contact the supplier. Do not attempt to install it.

## 2.5 Filament Voltage

The proper adjustment and regulation of filament voltage is the single most significant area where a tube user can affect tube life and performance.

### Metering

The metering of filament voltage on the majority of equipment is not accurate. Often the metering is a multimeter that is switched to read various operating parameters. To be useful for filament metering, the meter must be calibrated to read voltage at the tube socket and must be capable of being read accurately to one tenth of a volt. Often the filament voltage is measured at the output of the filament transformer. In high current circuits such as the filament, the voltage drop in the wires going to the tube can be significant. All filament meters should be calibrated with an accurate iron-vane or rms-responding digital meter. The object is to determine the *heating value* of the power being supplied to the filament. The calibration voltage should be taken at the tube socket or connections with the filament operating. This will compensate for any line drop losses. In locations where the line voltage fluctuates more than 5 percent, the supply to the filament transformer should be equipped with a constant-voltage transformer (i.e., Sola transformer). A diagram of a filament supply circuit capable of precise adjustment over the most beneficial voltage range is shown in Figure 7. The circuit given assumes a 240 V supply to the circuit. Specific design criteria include the following:

- **Component 1.** Sola constant-voltage transformer connected to the supply line; sized for the KVA rating of filament.
- **Component 2.** Variac variable auto transformer controlling a fixed step-down transformer connected in a buck or boost configuration; KVA rating equal to 10 percent of the filament KVA.
- **Component 3.** A 240-to-24 volt secondary fixed transformer; KVA rating  $\geq$  10 percent of the filament KVA.
- **Component 4.** The existing filament transformer.

Mount the variable transformer such that it is adjustable from the control panel of the equipment. This will allow adjustment of the filament voltage while the equipment is operating. Unfortunately many transmitters and most industrial equipment are built with a filament transformer that has, at the most, taps located inside the equipment for the adjustment of filament voltage. If the equipment is operated for long periods of time, the filament circuit should be modified as shown.

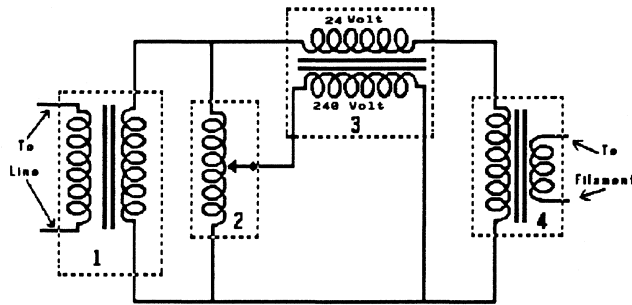

Figure 7. Adjustable filament supply circuit.

### Filament Operation

The thoriated tungsten filaments used in power vacuum tubes depend upon sufficient filament temperature to provide adequate electron emission for normal operation. Power tubes should not be operated in the *emission-limited* mode. The use of filament voltage to control output power is not the correct method of operation. It will destroy a tube quicker than operation at higher than permissible voltages.

The operator, by adjusting the filament voltage, can control the operating temperature. Each tube is unique; while one tube may make full operating power at a filament voltage of 7.3 V, a replacement device may require 7.4 V to attain the same power. It is for this reason that we recommend all tuning be done at the rated filament voltage. After tuning is complete, then the voltage can be reduced to provide extended life.

Though cathodic type tubes can be damaged by operation of the heater at reduced filament voltage, we have never seen a case where operation at the proper reduced voltage after tuning is anything but beneficial to directly heated filamentary tubes. It is important, however, to operate the tube at rated voltage for the first 100 to 200 hours before reducing it as described in the next section.

### Initial Operation and Tuning

Upon initial installation, the filament should be run for a period of 100 to 200 hours at its rated filament voltage. This initial operation allows the *getters*, materials that absorb and hold residual gas, to finish the vacuum of the tube in its actual operating environment. After this initial run-in time, it is good practice to operate the filament at reduced voltage, provided that proper operating parameters can be obtained at the reduced voltage.

First, tune and run the equipment to normal operation with the filament at rated voltage; then, without changing any other adjustments, reduce the filament voltage until the tube deviates from normal operating conditions. This point is the beginning of emission limited operation. Continued operation at this point can be destructive to the tube. Raise the voltage to one or two tenths of a volt above the lowest voltage where the tube worked properly. This should maximize tube life at no reduction in performance. The one to two tenths setting above the emission

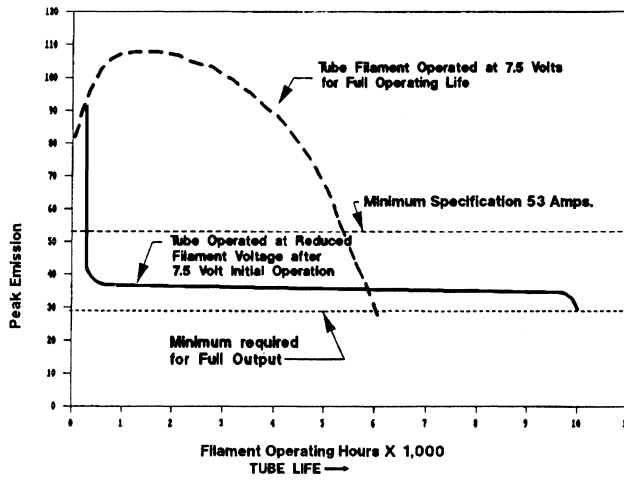

Figure 8. Filament life vs. peak filament emissions for a 4CX5000A.

limited voltage allows for minor line fluctuations and requires less frequent adjustment as the tube ages.

A power tube operated in this manner will generally yield life 50 percent greater than a tube run continuously at rated filament voltage. If the tube is removed and then replaced, it is not necessary to run it at rated voltage beyond the time necessary to tune the equipment.

Figure 8 illustrates the impact of filament voltage on peak emissions with a common tetrode. Figure 9 charts filament current as a function of operating hours.

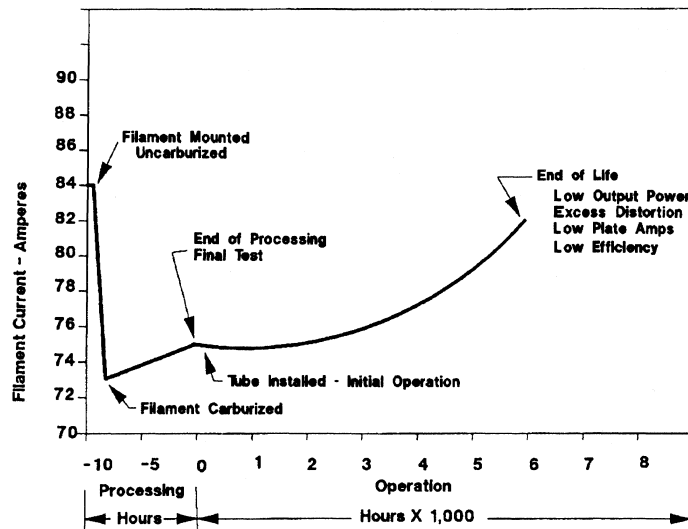

Figure 9. The effect of filament current on the operating hours of a 4CX5000A.

## 2.6 Tube Life

In the majority of applications, normal end of life for a power tube is determined when, due to decarburization of the filament, the electron emission of the filament falls below the point where, at rated filament voltage, it is no longer adequate to sustain full output power or distortion levels exceed allowable limits.

Carburization is the process where in manufacturing, carbon is—under specific conditions of temperature and pressure—burned into the raw *thoriated tungsten* filament. This process is monitored by a decrease in the filament current at rated voltage. As a tube operates, carbon slowly is burned out of the filament.

Three factors are primary in determining the number of hours a tube will operate before reaching end of life:

- The amount of carbon originally processed into the filament. The maximum amount of carbon that can be burned into a filament is limited by increasing fragility as the carbon level is increased and by a lowering of the filament temperature to the point where the tube lacks adequate emission to make power at rated filament voltage.
- The residual vacuum level in the tube. The quality of the vacuum affects life because the rate of decarburization is a function of residual gasses, primarily oxygen and nitrogen, reacting with the filament to cause decarburization. Good vacuum processing and proper gettering result in the lowest residual gas levels. Getters are materials placed within the tube envelope that when heated absorb and hold residual gasses within the tube. This gettering action improves the ultimate vacuum within the tube envelope. Gettering action continues throughout the life of the tube, however the most beneficial action occurs in the first few hours of operation.
- The rate of decarburization, which increases with the operating temperature of the filament. The filament temperature is determined by power on the filament and therefore controllable by adjustment of the filament voltage.

These various items, taken together, determine the normal life of a power tube. In broadcast transmitters that operate into a fixed load, the vast majority of failures result from a loss of emission caused by decarburization. Industrial applications, such as dielectric or induction heating, often experience a higher percentage of catastrophic failures.

Equipment problems related to tubes fall into three categories:

- Catastrophic
- Intermittent
- Performance

Table 1 lists general guidelines for extended tube life.

**Table 1.** Checklist for Long Tube Life

	Promptly check tubes when received for shorts and freight damage.
	Store tube in a dry location in its original box, safe from shock and bumping.
	Install the tube and tube equipment with the filament at its rated normal voltage.
	Run tube for several weeks at rated normal filament voltage.
	Reduce filament voltage to increase tube life after initial run-in.
	Replace or clean filters as required.
	Maintain proper water quality and flow on all water and vapor cooled tubes.
	Keep an accurate and up to date log of equipment behavior and meter readings.

### Catastrophic Failures

A catastrophic failure can take on a number of forms, however, the symptoms are usually the same: overload relay trips and/or circuit breaker trips. Repeated attempts to restart the equipment can cause damage to the circuitry so it is good practice to troubleshoot the system immediately upon the first indication of overload. To begin, make a visual inspection of the high voltage areas of the equipment. Look for burned wires and components. If you have reason to suspect the tube, remove it, making sure that the high voltage connections are located so as to prevent shorting to ground or other components. With the tube removed, reapply voltages. If the equipment does not trip off, then you can be reasonably sure that the problem is the tube or the tube/circuit interface. At this point, unless a specific problem has been found, we recommend that the tube be sent to ECONCO for testing and analysis.

Catastrophic failures can be caused either by broken or warped elements shorting to each other within the tube, or a puncture in the vacuum envelope allowing air to enter the device. Air in a tube causes a loss of dielectric standoff between the internal tube elements. Both shorted elements and loss of vacuum will cause overloads in operating equipment.

Catastrophic failures that occur during initial installation are usually the result of broken elements. Those that occur after initial operation are more likely the result of a loss of vacuum. In either case, continued efforts to bring the tube up can result in considerable damage to the tube and other components. Overloads and circuit breakers are not fast enough to forestall many types of damage.

### Intermittent Failures

Intermittent overloads (*kickoffs*) are the hardest to pin down. They can be caused by circuit operating conditions or internal tube failures. In transmitters, they can be the result of a broken or warped filament moving around and occasionally short-circuiting to the grid, causing loss of grid bias. Loss of grid bias in tubes requiring a bias voltage allows full plate current to flow, activating the overload protection circuit(s). In industrial applications, intermittent overloads can also be caused by shorting across the load.

### Performance Failures

Performance failures occur when the equipment will not produce normal output with the normal operating values set. One method of quickly checking to determine if low emission in the tube is the likely cause is to raise the filament voltage several tenths of a volt. If the output increases dramatically, then you can be quite sure that the problem is low emission. No danger of burning out the filament exists, as most designs are capable of temporarily withstanding twice their rated filament voltage. Raise the filament voltage to a point where the output returns to normal. If voltage in excess of rated normal is required, the tube is due for replacement. For short periods of time, you can run the filament in excess of normal rated voltage, however in a tube with a mesh or spiral filament, the risk of thermal shorting is increased. In any case, the tube should be replaced as soon as possible when full output can no longer be obtained at rated filament voltage.

## 2.7 Evaluating Tube Performance

Examination of a power tube after it has been removed from a transmitter or other type of generator can reveal a great deal about how well the equipment-tube combination is working. Contrast the appearance of a new power tube with a component at the end of its useful life. If a power tube fails prematurely, the device should be examined to determine whether an abnormal operating condition exists within the transmitter. Consider the following examples:

- Figure 9. Two 4CX15000A power tubes with differing anode heat-dissipation patterns. Tube (a) experienced excessive heating because of a lack of PA compartment cooling air or excessive dissipation because of poor tuning. Tube (b) shows a normal thermal pattern for a silver-plated 4CX15000A. As mentioned previously, nickel-plated tubes do not show signs of heating because of the high heat resistance of nickel.

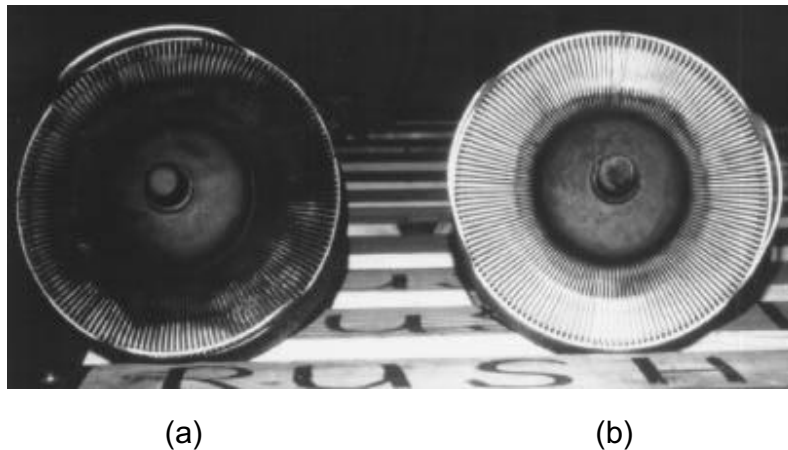

**Figure 9.** Anode dissipation patterns on two 4CX15000A tubes: (a) excessive heating, (b) normal wear

- Figure 10. Base-heating patterns on two 4CX15000A tubes. Tube (a) shows evidence of excessive heating because of high filament voltage or lack of cooling air directed toward the base of the device. Tube (b) shows a typical heating pattern with normal filament voltage.

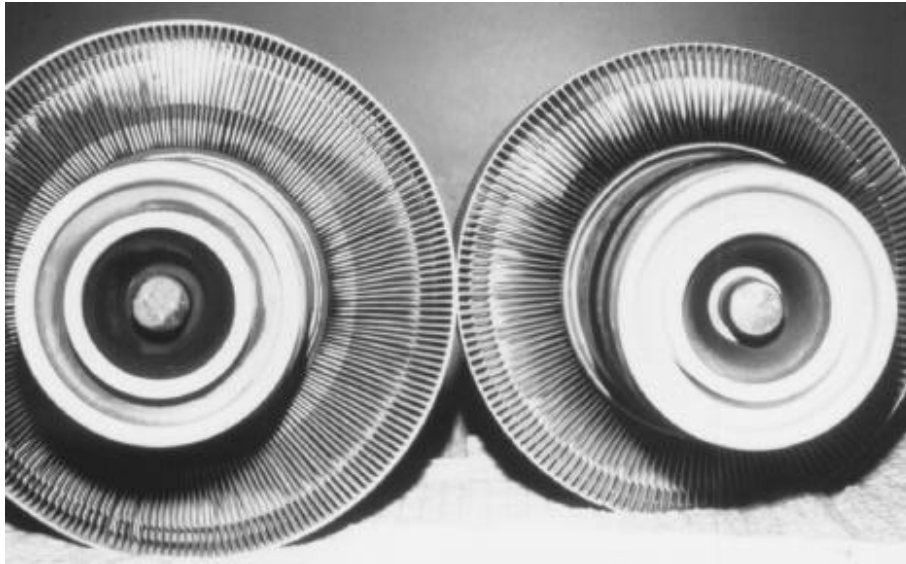

(a) (b)  
**Figure 10.** Base heating patterns on two 4CX15000A tubes: (a) excessive heating,  
 (b) normal wear

- Figure 11. A 4CX5000A tube with burning on the screen-to-anode ceramic. Exterior arcing of this type generally indicates a socketing problem, or another condition external to the tube.
- Figure 12. The stem portion of a 4CX15000A tube that had gone down to air while the filament was on. Note the deposits of tungsten oxide formed when the filament burned up. The grids are burned and melted because of the ionization arcs that subsequently occurred. A failure of this type will trip overload breakers in the RF generator. It is indistinguishable from a short-circuited tube in operation.
- Figure 13. A 4CX15000A tube that experienced arcing typical of a bent finger-stock, or exterior arcing caused by components other than the tube.





**Figure 11.** A4CX5000A tubes that appears to have suffered socketing problems.

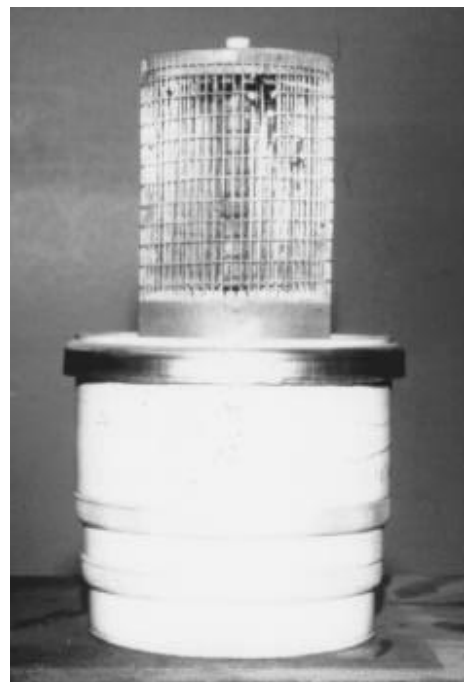

**Figure 12.** The interior elements of a 4CX15000A tube that had gone to air while the filament was lit.



**Figure 13.** A 4CX15000A tube showing signs of external arcing.

## 2.8 Shipping and Handling

Because of their fragile nature, tubes are packaged for shipment in foam filled or spring supported shipping containers. When it is necessary to ship or transport a tube from one location to another, it is good practice to put them in their original shipping containers. If the original packing is unavailable, for tubes weighing up to 25 pounds, a minimum of two inches of bubble pack will protect the device. Larger tubes require more protection. Vacuum tubes should be removed whenever the equipment is moved. Tubes should never be left installed during an equipment move.

### Storage

Tubes should be wrapped in a plastic bag to protect them from moisture and stored in their shipping boxes. If it is necessary to store tubes loose, they should be located so as to reduce the chance of accidental breakage resulting from dropping or shock. Also, they should not be stored in high-moisture environments.

### Handling

Power tubes are fragile. Filaments can be broken by setting the tube down too hard on a solid surface. Do not lie a tube on its side; the filaments can break if it rolls along a surface. Some radio frequency industrial equipment is routinely moved to various locations within a plant. Equipment used in this manner should be equipped with air filled casters, never solid casters.

### Marking

Never write on any portion of the ceramic or on any contact surface. Some engineers are in the habit of writing notes on the tube bodies for record keeping purposes, but this is not a good practice. Use a separate note card instead.

### **Shelf Life**

Modern power tubes with metal and ceramic vacuum envelopes are not prone to *gassing up* while in storage. Experience indicates that these tube types can be stored indefinitely without deterioration. It is not necessary to periodically rotate them through an operating socket to degas the tube. Experience shows that you stand a greater chance of breaking the tube or socket fingerstock than any benefit gained by degassing.

Older designs, using glass as an insulating medium, do tend to leak gas over time. It is not the glass that is porous to gas, but the Kovar alloy used to seal the glass to metal parts in the tube. Kovar is also subject to rusting when moisture is present. Such devices should be kept in a sealed plastic bag in storage and rotated through the equipment at least once every twelve months. Physically, the larger the tube, the more surface area of Kovar, and the greater the possibility of gassing up.

### **Degassing**

Tubes that may have gassed up can be partially degassed by putting them in the equipment and running them for several hours with filament voltage only applied. After the initial filament-only degassing; operation for an hour or so at reduced plate and screen voltages is desirable. This allows the getter to soak up and hold any residual gasses. In directly-heated filamentary tubes, the getters are generally zirconium-bearing materials, which depend on heat to activate the gettering action.

### **Manufacturers Support**

ECONCO is happy to provide telephone support to any tube user who is experiencing problems with a tube. This service is available to all tube users regardless of their source of tubes. We can provide copies of data sheets for most common power tubes.



### Section 3: The Tube Rebuilding Process

When a tube is received at the ECONCO plant to be rebuilt, it is first electrically tested and analyzed to determine what type of work must be done by our technicians to restore it to “like new” condition. After rebuilding, each tube is tested to the original manufacturer’s specifications and/or the appropriate MIL spec (or equivalent).

#### 3.1 Device Testing

Static tests insure that the tube geometry and internal structure are as originally intended by the tube designer. Among the key static tests are filament current, *cutoff*, gas, and peak emission. Each of these imparts the following data.

- **Filament current.** Filament current continually increases during operation of a tube. The increase from the starting value on a tube is a measure of the amount of usage. In the absence of accurate recorded operating hours, it is possible to estimate the usage. By the same method, with accurate hours we can determine the operating temperature of the filament in an application. When evaluating short life difficulties, this is extremely helpful information.
- **Cutoff.** Because the emission capability of a cathode is normally many amperes and at normal bias the plate current is the result of the average fields within the tube, it is impossible to evaluate the concentricity of a structure. However, if the current is reduced to a few milliamps and the plate voltage is raised to a very high value, then only a small part of the cathode is needed to give the few milliamperes, and the degree of structure eccentricity is proportional to the bias voltage. The greater the eccentricity, the greater the bias required to reduce the plate current. Each tube type has a different range of acceptable values.
- **Gas.** A high vacuum within the tube envelope is important to proper operation and long life. All gas tests measure the quantity of electrons required to neutralize positive gas ions created by current through the tube. Positive gas ions are collected on the most negative element within the tube. The classic test is performed with sufficient plate voltage and average current to affect the rated plate dissipation while the grid remains negative. Gas currents range

from about one microamp to nearly one milliamp on large tubes. This reading includes currents from inter-element leakage or grid emission. It is almost impossible to separate the components of this test.

A more accurate gas evaluation can be obtained by the *IZ* test, which converts the tube under test to an *ion gauge*. An ion gauge has the anode operating at a negative potential. The control grid is operated positive and the current controlled by adjusting the filament voltage. Gas ions are neutralized on the anode and the neutralizing current is measured. This test is a true measure of internal gas. *IZ* currents range from hundredths of a microampere to not over one microamp.

- **Peak Emission.** In this test the saturated emission capability of the cathode is evaluated. If the emission is low, it is an indication of reduced cathode activity, and performance can be affected. Emission is evaluated with the tube connected as a diode with high voltage pulses (2500 V) applied across the tube and the resulting cathode current measured.

The previous tests define and identify a tube type. However, tube operation involves a more complex set of conditions. Fortunately, it is possible to simulate worst case conditions on all types. Constant current curves for each type are published. These curves are used by engineers to establish operating parameters during equipment design. These curves make it possible to accurately predict the power output and element currents. Using the constant current curves, it is possible to select the most demanding combination of instantaneous voltages and currents for any application. This point is normally found at the lowest anode voltage, highest anode current, and maximum drive voltage. At ECONCO, we use pulse techniques to measure the peak instantaneous values of the drive voltage and all electrode currents, and compare them to the published data. Figure 14 shows an oscilloscope presentation of the drive voltage and a current on a test console. In analyzing tube performance, it is frequently of great importance how the currents divide between the tube elements.

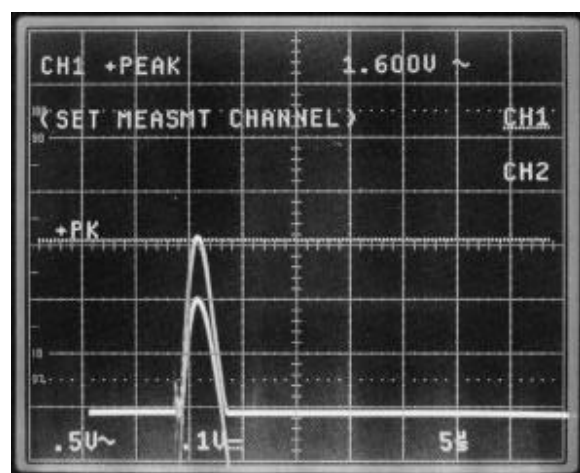

**Figure 14.** Oscilloscope representation of a pulse test of instantaneous drive voltage and electrode currents.

### 3.2 Steps in the Rebuilding Process

The following photos illustrate the process of power tube rebuilding, as practiced by ECONCO.

**Tube Test.** Incoming tubes are checked and, based on the measured results, they are routed to the proper rebuilding station. There, the vacuum envelope is opened; the internal elements are then removed as required for inspection and analysis. Experience has shown that many operational problems leave physical evidence within the structure and a thorough examination of the internal topography provides valuable information regarding the reason for failure, exceptional life, or outstanding performance.



**Carburizer.** The emission of a thoriated tungsten filament depends on a complex chemical process. One of the carbides of tungsten protects the filament from ion bombardment and acts as a catalyst to lower the temperature for efficient emission. Operation to new performance specifications requires careful measurement of internal dimensions and duplication of the original component configuration when the tube is rebuilt. Through analysis of a large number of tubes that have failed in the field, ECONCO engineers are sometimes able to improve on the original design and thereby extend tube life.



**Leak Detection.** Proper operation of a tube depends on a good vacuum within the envelope. The structure of the tube involves many different materials that are joined together. These joints must be vacuum tight. Here, seals are being checked on the mass spectrometer leak detector before further processing.

The operational life of a tube is highly dependent on the degree of vacuum in the envelope; the better the vacuum, the longer the life.



**Materials and Components.** Although ceramic has been replacing glass in power vacuum tubes, in many high voltage applications, glass is the preferred material. This tube has been opened on a glass lathe and is being prepared for rebuilding.

Vacuum tube manufacture requires special materials and close-tolerance matching of parts. In the rebuilding process, all original tube specifications are met or exceeded.



Glass sealing can be done either in a horizontal or vertical lathe. Here, a technician is sealing this 6696. With such glass lathes it is possible to manufacture new envelopes, which enable the rebuilding of tubes once considered irreparable.

After being sealed, the envelopes are annealed to relieve stress.



Tubes with cracked ceramics were previously considered unbuildable. Here, a 4CX3500A is prepared to have the cracked output ceramic removed and replaced.

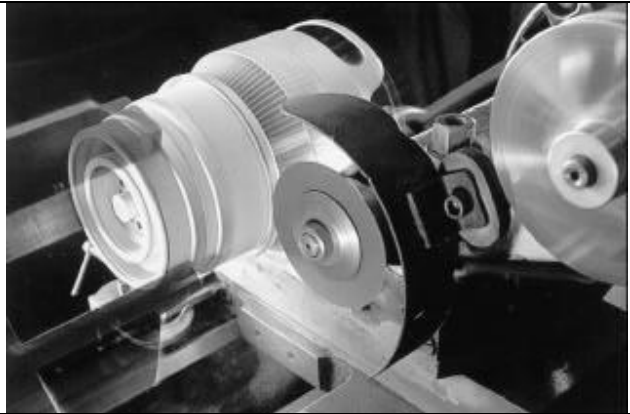

High temperature atmosphere furnaces are used to braze new ceramic onto prepared stem assemblies. Other furnace applications include *heat-setting* of metals and processing materials.

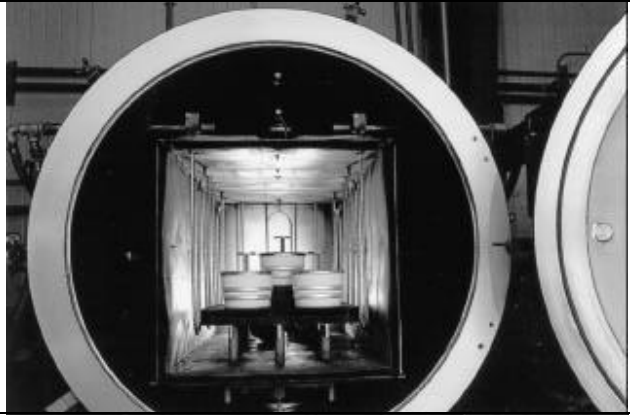

**Grid Structures.** Normal operation subjects the filament and grid structures to thermal and electrical stresses that can render them unusable in a rebuilt product. Modern tube technology requires extensive use of mesh cathodes, and special fabrication tools and jigs are used to replace the worn out cathodes. Here, a new mesh filament is being wrapped on a mandrel.





The original tube design establishes the overall performance characteristics. Replacement parts exactly duplicate the original parts in form, fit, and function. Jigs and fixtures aid in the production and assembly, but skilled tube technicians are the brains and hands that do the job.



**Anodes.** It is possible in the operation of certain industrial tubes that the anode can become damaged, and replacement with a new component is the only solution. ECONCO has the capability of manufacturing new anodes when necessary for a variety of tubes. The anode of a typical tube consists of four primary parts: the internal cup, external fins, the external anode band, and sealing rings.



**Tube Bank.** ECONCO buys duds whenever possible for the purpose of having an inventory of the most commonly used types already rebuilt and in stock for delivery. The customer has the option to have a tube from stock (when available) or have a specific dud rebuilt.



**A Tradition of Excellence.** The exterior finish on a tube contributes to proper operation. ECONCO believes that silver plate is the best finish for tubes unless other environmental considerations dictate another treatment. At ECONCO, we have the technology to rebuild a wide range of power tubes. Our tubes are used in numerous applications, including radio and television broadcasting, the defense industry, specialized communications systems, wood drying, dielectric heating of plastics, vinyl sealing, and semiconductor manufacturing





*Tube Topics*

#### Section 4: Maximum Tube Ratings for Devices Rebuilt by ECONCO

ECONCO has analyzed and rebuilt over 200,000 tubes of 500 different types during their 30 year history. The following is a table of maximum ratings for the most popular power tubes now being rebuilt by ECONCO.

Type	Filament		Kilovolts	Plate Amps
	Volts	Amps		
1173	5.4	65	10.0	1.75
22789	6.0	60	9.3	2.3
23454	22.5	235	20.0	20.0
23791	9.0	60	9.0	2.0
23795	9.0	60	9.0	3.0
23935	9.0	60	9.0	3.0
3CV30,000A3/H3	6.3	172	7.0	5.0
3CW10,000A3/H3	7.5	75	10.0	3.0
3CW20,000A1	7.5	100	7.0	5.0
3CW20,000A3	7.5	100	7.0	5.0
3CW20,000A7	7.5	104	7.0	5.0
3CW20,000H3	7.5	104	12.0	4.0
3CW20,000H7	7.5	104	7.0	5.0
3CW30,000H3	6.3	172	12.0	6.0
3CW30,000H7	6.3	160	8.0	6.0
3CW40,000H3	10.0	160	12.0	9.0
3CW5,000A1/F1	7.5	53	6.0	2.5
3CW5,000A3/F3	7.5	53	6.0	2.5
3CW5,000A7/F7	7.5	53	5.0	2.5
3CW5,000F3/H3	7.5	53	6.0	2.5
3CW5,000H3	7.5	53	6.0	2.5
3CX1,000A3	7.5	31	6.0	1.5
3CX1,000A7	6.3	25	5.0	0.8
3CX1,200A7	7.5	21	5.0	0.8
3CX1,200Z7/D7	6.3	25	5.0	0.8
3CX1,500H3/D3	6.3	25	7.0	0.8
3CX10,000A1	7.5	104	10.0	5.0
3CX10,000A3/H3	7.5	104	10.0	4.0
3CX10,000A7	7.5	104	8.0	5.0
3CX15,000A3/H3	6.3	160	8.0	6.0
3CX15,000A7	6.3	160	8.0	6.0
3CX2,500A3/F3/H3	7.5	53	6.0	2.5

3CX2,500D3	7.5	31	7.0	1.5
3CX20,000A3/H3	10.0	160	12.0	8.0
3CX20,000A7	6.3	160	8.0	6.0
3CX3,000A1/F1	7.5	53	6.0	2.5
3CX3,000A7/F7/H7	7.5	53	5.0	2.5
3CX4,500F3	7.0	78	9.0	3.0
3CX5,000H3	7.5	78	10.0	3.0
3CX6,000A7	7.0	78	7.0	3.5

Type	Filament		Kilovolts	Plate Amps
	Volts	Amps		
4CPW10,000R	7.5	78	7.5	4.0
4CV100,000C	10.0	300	20.0	15.0
4CV250,000B	12.0	660	20.0	40.0
4CV35,000A	6.3	168	10.0	6.0
4CV8,000A	9.0	43	7.0	2.0
4CW10,000A/B	7.5	78	7.5	4.0
4CW100,000D	10.0	295	20.0	15.0
4CW100,000E	15.5	215	20.0	16.0
4CW150,000E	15.5	215	22.0	20.0
4CW25,000A	6.3	160	10.0	6.0
4CW250,000B	12.0	660	20.0	40.0
4CW30,000A	10.0	140	10.0	6.0
4CW50,000E	12.0	215	17.5	12.0
4CX1,500A	5.0	38.5	5.0	1.0
4CX10,000D	7.5	78	7.5	4.0
4CX10,000J	7.5	108	7.5	4.0
4CX12,000A	6.5	120	10.0	3.5
4CX15,000A	6.3	160	10.0	6.0
4CX15,000J	7.5	158	10.0	6.0
4CX15,000R	6.3	160	10.0	6.0
4CX20,000A	10.0	140	10.0	6.0
4CX20,000B	10.0	140	10.0	6.0
4CX20,000C	10.0	140	12.5	6.0
4CX20,000D	7.5	145	12.5	5.0
4CX3,000A	9.0	43	7.0	2.0
4CX3,500A	5.0	90	5.5	2.0
4CX35,000C	10.0	295	20.0	15.0
4CX5,000A	7.5	78	7.5	4.0
4CX5,000R	7.5	78	7.5	4.0
4CX7,500A	7.0	110	6.5	3.0
5604	11.0	176	12.5	2.75
5606/A	11.0	176	12.5	2.75
5619	11.0	176	12.5	3.0
5658	12.0	28	12.5	5.0
5666	11.0	120	10.0	2.0
5667	11.0	120	10.0	2.0
5668	22.0	60	14.0	2.0
5681	12.0	220	15.0	11.0
5682	16.5	325	16.0	18.0
5736	6.0	60	3.5	1.5
5762	12.6	33	6.0	8.5
5771	7.5	170	12.0	4.0
5918A	11.0	285	17.5	15.0
5924A	12.6	36	6.0	1.9

5AC95	9.0	50	6.5	3.0
<b>Type</b>	<b>Filament Volts</b>	<b>Filament Amps</b>	<b>Kilovolts</b>	<b>Plate Amps</b>
5CX1,500A/B	5.0	40	5.0	1.0
5CX3,000A	9.0	43	7.0	2.0
6076	6.3	33	4.0	1.8
6366	11.0	29	6.2	1.3
6367	13.0	36	6.2	2.0
6379	11.0	285	17.5	15.0
6399	11.0	29	6.2	1.3
6400/A	13.0	36	8.0	2.0
6420	7.0	85	10.0	2.2
6421/F	7.0	85	10.0	2.2
6422	7.0	85	12.5	2.5
6423/F	7.0	85	12.5	2.5
6424	7.0	120	12.5	3.5
6425/F	7.0	120	12.5	3.5
6426	8.0	200	12.5	8.0
6427	8.0	200	12.5	7.0
6623	6.0	63	9.3	2.3
6696/A	13.0	205	16.0	11.0
6697/A	13.0	205	16.0	11.0
6960	12.6	33	7.2	2.2
7007	5.0	180	7.5	4.0
7237A	12.6	33	7.2	2.2
7459	12.6	33	6.0	1.9
7480	13.0	205	16.0	11.0
7482	14.5	450	20.0	30.0
7560	14.5	450	20.0	30.0
7804	6.3	136	8.0	4.0
7806	8.0	130	13.0	5.0
7807	7.0	110	8.0	5.0
7900	12.6	32	6.0	1.5
7C23	11.0	29	17.5	20.0 P
7C24	12.6	33	6.0	8.5
7C25	11.0	28	5.0	1.3
8104	15.0	36	8.0	2.5
8131	9.5	50	6.5	3.0
8132	9.5	50	6.2	3.0
8161R	7.5	51.5	6.0	2.5
8269	12.6	36	6.0	1.9
8386	14.5	330	17.0	16.0
8388	14.5	330	17.0	16.0
8680	12.6	380	16.8	25.0
8752	12.2	255	14.4	18.0
8772	13.0	205	16.0	11.0
8773	13.0	205	16.0	11.0
8795	16.5	325	20.0	20.0
<b>Type</b>	<b>Filament Volts</b>	<b>Filament Amps</b>	<b>Kilovolts</b>	<b>Plate Amps</b>
8801	7.0	175	9.0	6.0
8935	7.0	175	14.4	6.0

8952	5.8	130	12.0	4.0
8990	10.0	140	10.0	6.0
8C25A/N	11.0	28	5.0	1.3
9019	7.5	160	10.0	5.0
9T94	12.2	255	14.4	18.0
BR1606	6.6	100	10.0	4.5
BR1608J2F	12.0	178	13.0	12.0
BTL15-4	7.5	150	12.0	6.5
BTL25-4	10.0	320	15.0	9.0
BTS15-3	7.5	150	12.0	6.5
BTS25-4	10.0	320	15.0	9.0
BTW15-3	6.6	230	12.0	7.0
BTW50-4	20.0	200	15.0	19.0
BW1184	12.2	255	14.4	18.0
BW1185J2	12.6	380	16.8	25.0
BW1606J2F	6.6	100	10.0	4.5
BW1607J2F	7.5	100	10.0	5.0
BW1608J2F	12.0	178	13.0	12.0
CQK50-2	12.6	335	12.5	12.5
CQK650-1	12.0	1,700	15.0	65
CQS200-3	20.0	430	15.0	25.0
CQS50-2	12.6	335	15.0	14.0
FTL3-2	12.0	26	7.0	1.75
FTW3-2	12.0	26	7.0	1.75
ITK12-1	5.8	145	12.0	5.0
ITK200-1	22.0	375	18.0	50.0
ITK30-2	11.0	240	14.0	18.0
ITK60-2	13.0	250	14.0	5.0
ITK90-1	12.6	380	16.8	25.0
ITL12-1	5.8	145	12.0	5.0
ML356	7.5	170	12.5	6.0
ML880	12.6	35	10.5	6.0
MR1014	10.0	160	12.0	8.0
MR240	7.5	53	6.0	2.5
MR710	6.3	160	8.0	6.0
RFC399	6.3	160	8.0	6.0
RS2024CL	9.5	80	9.0	2.3
RS2032CL	9.5	80	9.0	2.3
RS2068CL	9.0	112	12.0	3.5
RS3021CJ	5.7	136	14.0	2.75
RS3026CJ	7.0	115	12.0	4.5
RS3040CJ	8.0	185	14.0	6.5
RS3060CJ	10.0	190	14.0	15.0

Type	Filament		Kilovolts	Plate Amps
	Volts	Amps		
RS3150CJ	15.0	255	15.0	25.0
RS3300CJ	16.0	425	17.0	37.5
RS3500CJ	17.5	510	18.0	60.0
TH150	9.0	60	9.0	3.0
TH298	6.0	50	5.0	2.5
TH327	5.8	34	5.0	2.0
TH347	5.8	34	5.0	1.25
TH361	7.0	140	7.0	6.0
TH382	4.2	125	5.5	3.0

TH393	6.0	65	6.0	1.25
TH5-4	7.5	51.5	6.0	2.5
TH558	23.0	500	15.0	60.0
TH5-6	7.5	51.5	6.0	2.5
TH561	7.0	140	7.0	6.0
TH582	4.2	146	5.5	5.5
TH593	5.8	65	6.0	3.0
TH6-1	7.5	104	10.0	4.0
TH6-3	7.5	104	10.0	4.0
TH6-3A	7.5	104	10.0	4.0
TH7-1	6.3	160	8.0	6.0
Y399	7.5	104	12.0	6.0
Y442	7.5	78	7.5	4.0
YC108	7.5	75	7.5	4.0
YC130	7.5	160	10.0	5.0
YD1160	6.3	66	6.0	2.2
YD1162	6.3	66	6.0	2.2
YD1172	5.8	130	7.2	4.0
YD1173	5.4	65	12.0	2.0
YD1175	5.8	130	10.0	3.4
YD1202	12.2	255	14.4	18.0
YD1212	12.6	380	16.8	25.0
YU108	7.0	78	9.0	3.0
YU148	7.0	78	7.0	3.5
YU199	7.0	78	9.0	3.0